

AMERICAN AVK EXTENSION KIT FOR DRY BARREL HYDRANTS
Extension kits in lengths of 6" to 60" in 6" increments
For all AVK Dry Barrel Hydrants

**27/70X
DBHEXT**

Standard Materials:

Extension Barrel, Standpipe Flanges

Ductile Iron ASTM A536

Extension Coupling, Coupling Pins, Lock Rings,
Spring Pins, Extension Stem Rod
Bolts, Nuts, Washers

Stainless Steel

Barrel Gasket

Nitrile rubber with stainless steel insert

Coatings

Standpipe Flanges - Fusion bonded epoxy coated.

Extension Barrel - Bitumen coated, inside and out

Optional Materials:

Bolts, Nuts, Washers

Stainless steel, 316

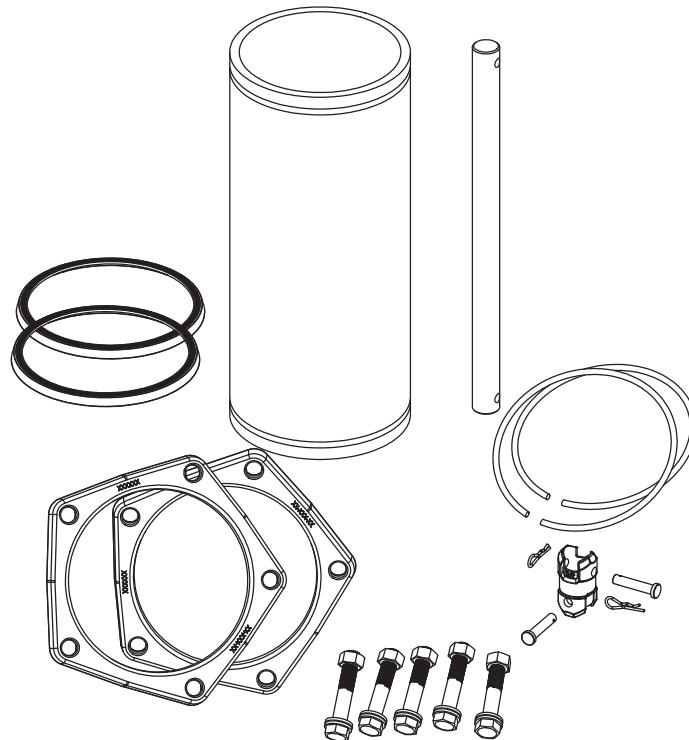

AMERICAN AVK EXTENSION KIT FOR DRY BARREL HYDRANTS
 Extension kits in lengths of 6" to 60" in 6" increments
 For all AVK Dry Barrel Hydrants

**27/70X
 DBHEXT**

Component List:

- | | |
|-------------------|---------------------------------|
| 17. Barrel Gasket | 42. Extension Coupling |
| 31. Washer | 43. Extension Barrel |
| 32. Lock Ring | 44. Upper/Extension Barrel Bolt |
| 34. Nut | 46. Standpipe Flange |
| 36. Coupler Pin | 48. Extension Stem Rod |
| 38. Spring Pin | |

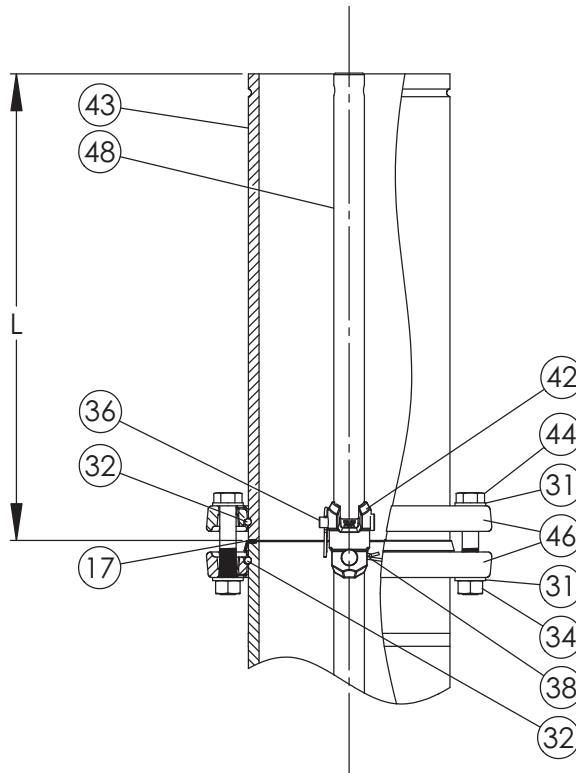

Ref. nos.	L	Weight Lbs per foot
27-150-70-X-100	6" - 60"	40
X = Length		
0 = 6"	4 = 30"	8 = 54"
1 = 12"	5 = 36"	9 = 60"
2 = 18"	6 = 42"	
3 = 24"	7 = 48"	

